



2-port seat valves PN16 with externally threaded connections

VVG44..

- Valve body bronze CC491K (Rg5)
- DN 15...DN 40
- k_{vs} 0.25...25 m³/h
- Flat sealing connections with external thread G..B to ISO 228-1
- Sets of ALG.. with threaded and ALS.. with weldable connection available from Siemens
- Manual adjustment by means of mounted knob
- Can be equipped with SQS.. actuators

Use

In small or medium-sized heating, ventilating and air conditioning plants as a control or safety shutoff valve. For closed circuits only.

Type summary

Type reference	DN	k_{vs} [m ³ /h]	S_v
VVG44.15-0.25	15	0.25	> 50
VVG44.15-0.4		0.4	
VVG44.15-0.63		0.63	
VVG44.15-1		1	
VVG44.15-1.6		1.6	
VVG44.15-2.5		2.5	
VVG44.15-4		4	
VVG44.20-6.3	20	6.3	> 100
VVG44.25-10	25	10	
VVG44.32-16	32	16	
VVG44.40-25	40	25	

DN = Nominal size

k_{vs} = Nominal flow rate of cold water (5...30 °C) through the fully open valve (H_{100}) by a differential pressure of 100 kPa (1 bar)

S_v = Rangeability k_{vs} / k_{vr}

k_{vr} = Smallest k_v value, at which the flow characteristic tolerances can still be maintained, by a differential pressure of 100 kPa (1 bar)

Zubehör

Type	Stock No.	Description
ALG..2 ¹⁾	ALG..2	Set of 2 screwed fittings, pipe side threaded for 2-port valves, consisting of - 2 union nuts, 2 discs and 2 flat seals ALG..2B are brass fittings, for media temperature up to 100 °C.
ALG..2B ¹⁾	S55846-Z1..	
ALS..2	ALS..2	Set of 2 screwed fittings, pipe side weldable for 2-port valves, consisting of - 2 union nuts, 2 discs and 2 flat seals

Order

When ordering please give quantity, product name and type reference.

Example:

Type	Stock No.	Description	Quantity
VVG44.25-10	VVG44.25-10	Valve	3
ALG252B	S55846-Z104	Set of screwed fitting	2

Delivery

Valves, actuators and accessories are packed and supplied separately.

Spare parts, rev. no.

See overview, page 6.

Equipment combinations

Valves	Actuators SQS..		Fitting sets			
	Δp_{max} [kPa]	Δp_s [kPa]	malleable cast iron Type / Stock No.	threaded		weldable steel Type / Stock No.
				brass ¹⁾		
			Type	Stock No.		
VVG44.15-0.25	400	1600	ALG152	ALG152B	S55846-Z100	ALS202
VVG44.15-0.4						
VVG44.15-0.63						
VVG44.15-1		725				
VVG44.15-1.6						
VVG44.15-2.5		400				
VVG44.15-4						
VVG44.20-6.3	750	ALG202	ALG202B	S55846-Z102	ALS252	
VVG44.25-10	400	ALG252	ALG252B	S55846-Z104		
VVG44.32-16	250	250	ALG322	ALG322B	S55846-Z106	
VVG44.40-25	125	125	ALG402	ALG402B	S55846-Z108	

¹⁾ For media up to 100 °C

Δp_{max} = Maximum permissible differential pressure across valve's control path, valid for the entire actuating range of the motorized valve

Δp_s = Maximum permissible differential pressure at which the motorized valve will close securely against the pressure (close off pressure)

Actuator overview

Type reference	Operating voltage	Positioning signal		Positioning time	Spring return		Data sheet
SQS35.00	AC 230 V	3 position		150 s	yes	8 s	N4573
SQS35.03				35 s			
SQS35.50				150 s			
SQS35.53				35 s			
SQS65.5	AC 24 V	DC 0...10 V	0...1000 Ω	35 s	yes	8 s	
SQS65		DC 2...10 V					
SQS65.2		3 position		150 s			
SQS85.00				35 s			
SQS85.03							

Technical design / mechanical design

Valve cross section

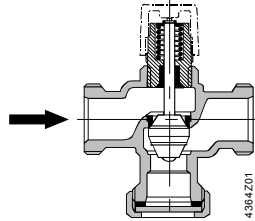

Guided parabolic plug which is attached to the valve stem.

The seat is molded in the valve body with special sealing material.



The 2-port seat valve does not become a 3-port valve by removing the seal cover!

Sizing

Flow diagram

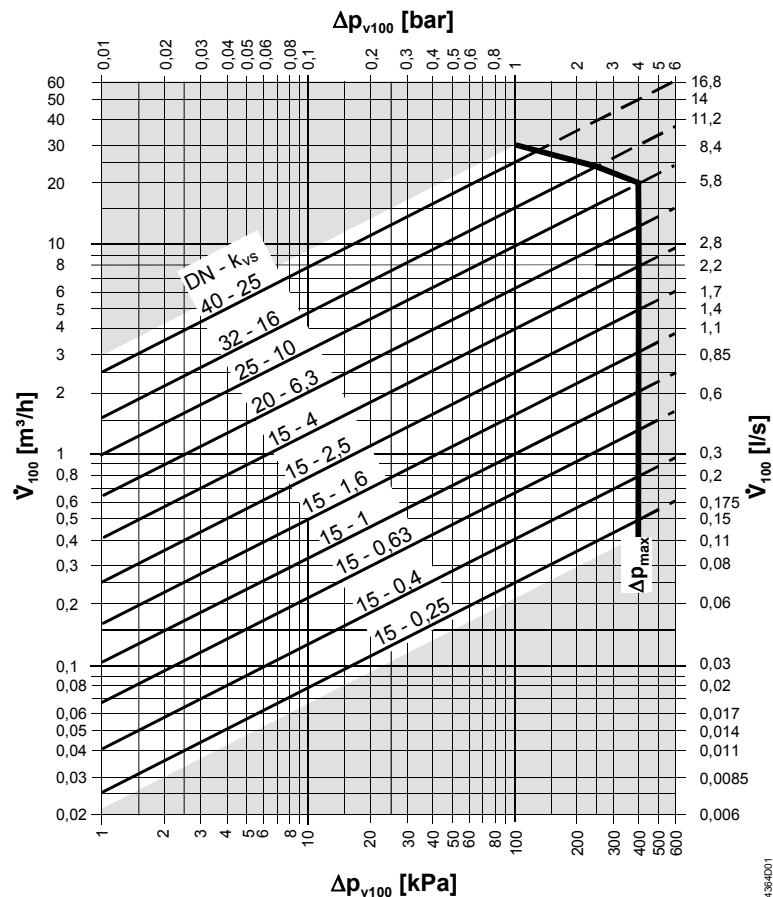

Δp_{max} = Maximum permissible differential pressure across the valve's control path, valid for the entire actuating range of the motorized valve

Δp_{v100} = Differential pressure across the fully open valve and the valve's control path by a volume flow V_{100}

\dot{V}_{100} = Volume flow through the fully open valve (H_{100})

100 kPa = 1 bar \approx 10 mWC

1 m³/h = 0.278 l/s water at 20 °C

Valve flow characteristic

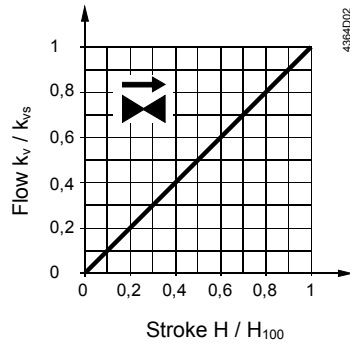

0...100 % linear to VDI / VDE 2173

Working pressure and temperature

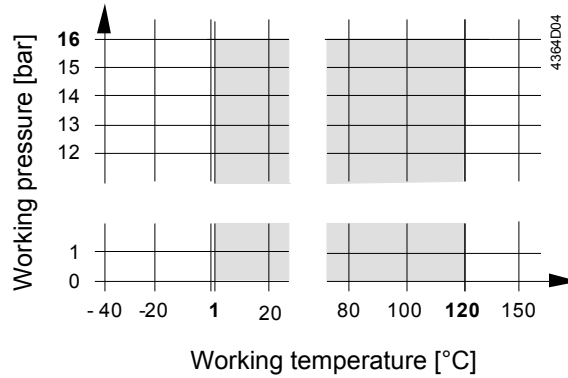

Working pressure and medium temperature staged as per ISO 7005

Current local legislation must be observed.

Notes

Engineering

We recommend installation in the return pipe, as the temperatures in this pipe are lower for applications in heating systems, which in turn, extends the stem sealing gland's life.

Always use a strainer upstream of the valve to increase the valve's functional safety.

Mounting

Both valve and actuator can easily be assembled at the mounting location. Neither special tools nor adjustments are required.

The valve is supplied with Mounting Instructions 4 319 9564 0.

Orientation

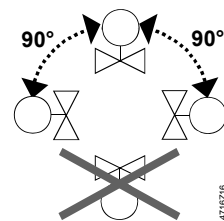

Direction of flow

When mounting, pay attention to the valve's flow direction symbol →.

Commissioning



Commission the valve only if the actuator has been mounted correctly.

Valve stem retracts: valve opens = increasing flow
 Valve stem extends: valve closes = decreasing flow

Maintenance

Warning

VVG44.. valves require no maintenance.

When doing service work on the valve / actuator:

- Deactivate the pump and turn off the power supply
- Close the shutoff valves
- Fully reduce the pressure in the piping system, allow pipes to completely cool down
If necessary, disconnect the electrical wires.

Before putting the valve into operation again, make certain the actuator is correctly fitted.

Stem sealing gland

The stem sealing gland cannot be exchanged. In the case of leakage, the entire valve must be replaced. Contact your local office or branch.

Disposal



Before disposal the valve must be dismantled and separated into its various constituent materials.

Legislation may demand special handling of certain components, or it may be sensible from an ecological point of view.

Current local legislation must be observed.

Warranty

The technical data given for these applications is valid only in conjunction with the Siemens actuators as detailed under "Equipment combinations", page 2.

All terms of the warranty will be invalidated by the use of actuators from other manufacturers.

Technical data

Functional data	PN class	PN 16 to ISO 7268	
	Operating pressure	to ISO 7005 within the permissible medium temperature range according to the diagram page 4	
	Flow characteristic 0...100 %	linear to VDI / VDE 2173	
	Leakage rate	0...0.02 % of k_{vs} value to DIN EN 1349	
	Permissible media	chilled water, low temperature hot water, water with anti-freeze. recommendation: water treatment to VDI 2035	
	Medium temperature	1...120 °C	
	Rangeability S_v	DN 15: > 50 resp. > 100 refer to "Type summary" DN ≥20: >100	
	Nominal stroke	5.5 mm	
	Industry standards	Pressure Equipment Directive	PED 97/23/EC
		Pressure Accessories	As per article 1, section 2.1.4
Fluid group 2		without CE-marking as per article 3, section 3 (sound engineering practice)	
Environmental compatibility		ISO 14001 (Environment) ISO 9001 (Quality) SN 36350 (Environmentally compatible products) RL 2002/95/EG (RoHS)	
Materials	Valve body	bronze CC491K (Rg5) as per EN 1982	
	Seat, stem, plug	stainless steel, bronze CC491K (Rg5), brass	
	Sealing gland	brass	
Dimensions / Weight	gland materials	EPDM O rings	
	Refer to "Dimensions", page 6		
	External thread connections	G..B to ISO 228-1	
	Actuator connection	G ¾"	

Dimensions

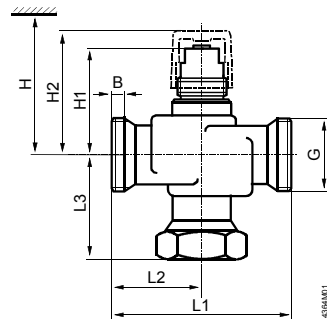

- DN = Nominal size
 H = Total actuator height plus minimum distance to the wall or the ceiling for mounting, connection, operation, service, etc.
 H1 = Dimension from the pipe centre to install the actuator
 H2 = Pipe centre to upper edge of manual adjustment button, valve in «closed» position

Type reference	DN	B [mm]	G ["]	L1 [mm]	L2 [mm]	L3 [mm]	H1 [mm]	H2 [mm]	H SQS..	Weight [kg]			
VVG44.15-0.25	15	8.5	G 1B	100	50	58	45	55	> 364	0,65			
VVG44.15-0.4							49	59					
VVG44.15-0.63							53	63					
VVG44.15-1							59	78			> 379	1,0	
VVG44.15-1.6							62.5	71			81	> 382	1,48
VVG44.15-2.5							63.5	77.5			87.5	> 389	1.95
VVG44.15-4	12			130	65	76	80.5	90.5	> 392	2.75			
VVG44.20-6.3	20	9	G 1¼B										
VVG44.25-10	25	11	G 1½B	105	52.5	62.5	71	81	> 382	1,48			
VVG44.32-16	32		G 2B			63.5	77.5	87.5	> 389	1.95			
VVG44.40-25	40		G 2¼B			76	80.5	90.5	> 392	2.75			

Screwed fittings

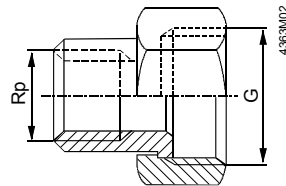

Type / Stock No.	Type	Stock No.	for valve type	G [Inch]	Rp [Inch]
ALG152	ALG152B	S55846-Z100	VVG44.15..	G 1	Rp ½
ALG202	ALG202B	S55846-Z102	VVG44.20	G 1¼	Rp ¾
ALG252	ALG252B	S55846-Z104	VVG44.25	G 1½	Rp 1
ALG322	ALG322B	S55846-Z106	VVG44.32	G 2	Rp 1¼
ALG402	ALG402B	S55846-Z108	VVG44.40	G 2¼	Rp 1½

- On valve side: cylindrical thread to ISO 228-1
- On pipe side: with cylindrical thread to ISO 7-1
- ALG..B for media temperature up to 100 °C

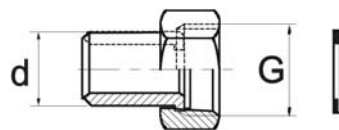

Type / Stock No.	for valve type	G [Inch]	Ø D [mm]
ALS202	VVG44.15..	G 1	26.8
ALS252	VVG44.20	G 1¼	33.7
	VVG44.25		
	VVG44.32		
	VVG44.40		

Spare parts

Type	Stock No.	Description	Number
74 6760 273 0	74 6760 273 0	Manual knob for short stroke valves	1

Revision numbers

Type	Valid from rev. no.	Type	Valid from rev. no.	Type	Valid from rev. no.
VVG44.15-0.25	..01	VVG44.15-1.6	..01	VVG44.25-10	..01
VVG44.15-0.4	..01	VVG44.15-2.5	..01	VVG44.32-16	..01
VVG44.15-0.63	..01	VVG44.15-4	..01	VVG44.40-25	..01
VVG44.15-1	..01	VVG44.20-6.3	..01		